

CLARK[®]

by Larson-Juhl

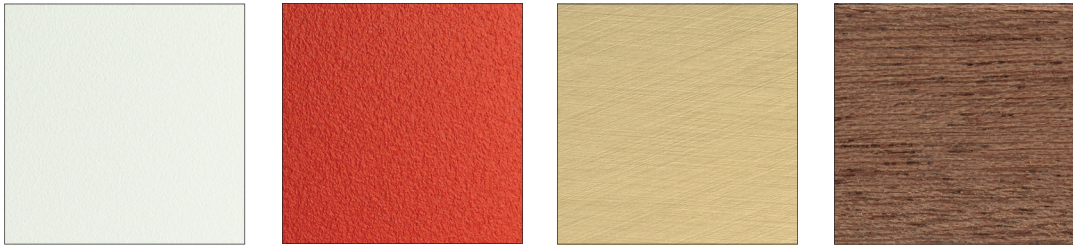

BARTH[®]
LARSON · JUHL

Brochure 2017



PROFIELSERIE 403-

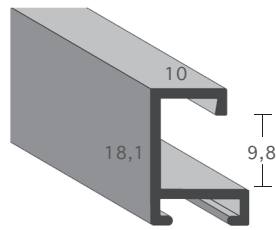

ARTIKELNUMMER	OMSCHRIJVING	CA. BREEDTE *MM
403 010 123	Geborsteld zilver mat	10
403 010 143	Kruisgeborsteld zilver	10
403 011 123	Geborsteld champagne mat	10
403 011 143	Kruisgeborsteld champagne	10
403 012 123	Geborsteld goud mat	10
403 012 143	Kruisgeborsteld goud	10
403 013 123	Geborsteld zwart mat	10
403 013 143	Kruisgeborsteld zwart	10



CLARK by Larson-Juhl Aluminium staaflijsten

PROFIELSERIE 404-

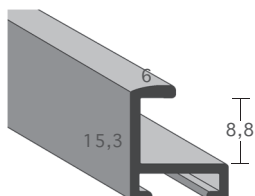

ARTIKELNUMMER	OMSCHRIJVING	CA. BREEDTE *MM
404 010 123	Geborsteld zilver mat	6
404 010 143	Kruisgeborsteld zilver	6
404 010 493	Glanzend geborsteld zilver	6
404 011 123	Geborsteld champagne mat	6
404 011 143	Kruisgeborsteld champagne	6
404 011 493	Glanzend geborsteld champagne	6
404 012 123	Geborsteld goud mat	6
404 012 143	Kruisgeborsteld goud	6
404 012 493	Glanzend geborsteld goud	6
404 013 123	Geborsteld zwart mat	6
404 013 143	Kruisgeborsteld zwart	6
404 013 493	Glanzend geborsteld zwart	6
404 013 253	Zwart poedercoating	6
404 017 253	Blauw poedercoating	6
404 022 253	Wit poedercoating	6
404 023 253	Rood poedercoating	6
404 024 253	Geel poedercoating	6
404 025 253	Groen poedercoating	6
404 026 253	Grijs poedercoating	6

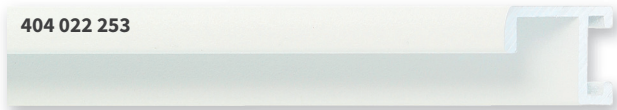
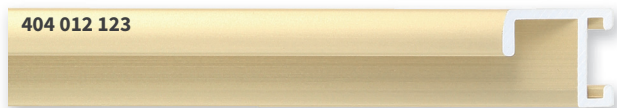
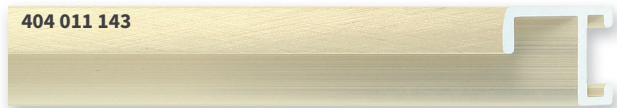

CLARK by Larson-Juhl Aluminium staaflijsten

PROFIELSERIE 411-

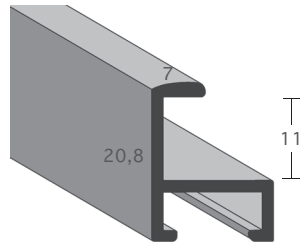

ARTIKELNUMMER	OMSCHRIJVING	CA. BREEDTE *MM
411 010 113	ECO zilver mat	7
411 010 123	Geborsteld zilver mat	7
411 010 143	Kruisgeborsteld zilver	7
411 010 493	Glanzend geborsteld zilver	7
411 011 123	Geborsteld champagne mat	7
411 011 143	Kruisgeborsteld champagne	7
411 011 493	Glanzend geborsteld champagne	7
411 012 123	Geborsteld goud mat	7
411 012 143	Kruisgeborsteld goud	7
411 012 493	Glanzend geborsteld goud	7
411 013 113	ECO zwart mat	7
411 013 123	Geborsteld zwart mat	7
411 013 143	Kruisgeborsteld zwart	7
411 013 493	Glanzend geborsteld zwart	7
411 013 253	Zwart poedercoating	7
411 016 173	Geborsteld brons	7
411 017 253	Blauw poedercoating	7
411 022 253	Wit poedercoating	7
411 023 253	Rood poedercoating	7
411 024 253	Geel poedercoating	7
411 025 253	Groen poedercoating	7
411 026 253	Grijs poedercoating	7

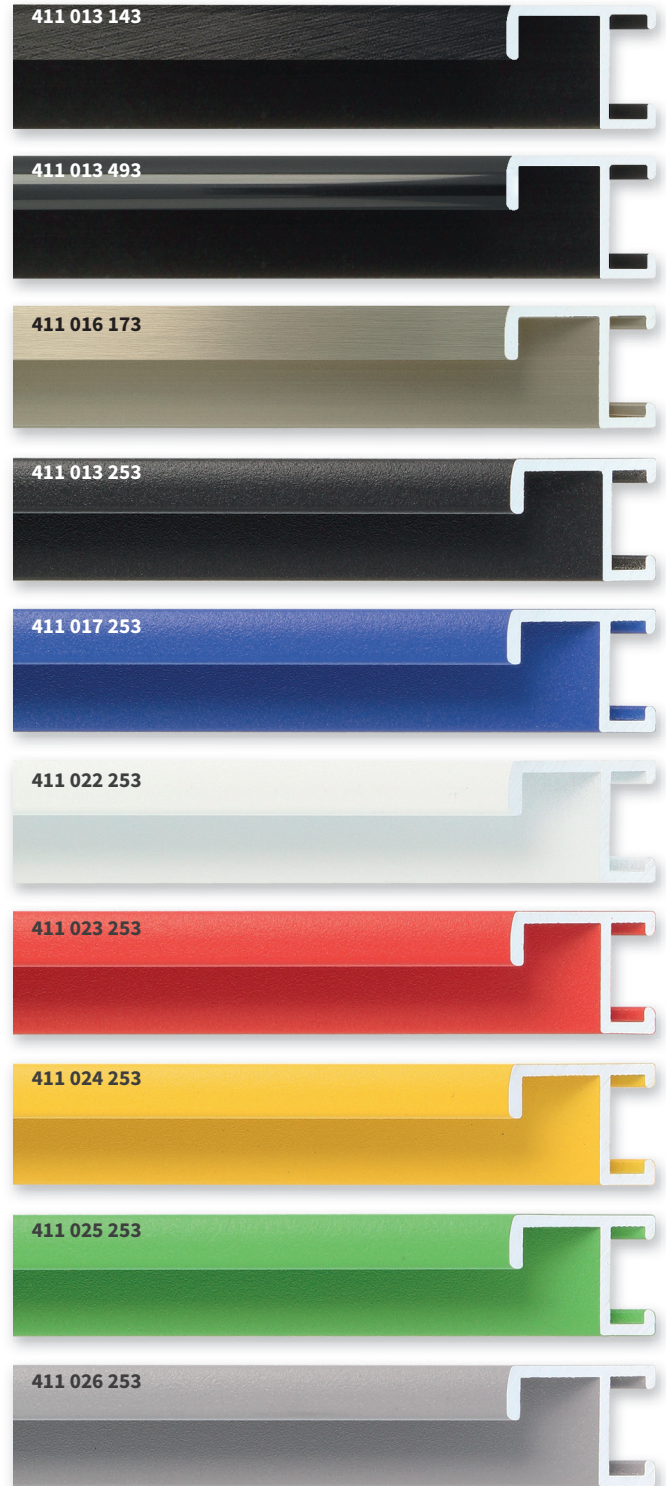

CLARK by Larson-Juhl Aluminium staaflijsten

PROFIELSERIE 415-

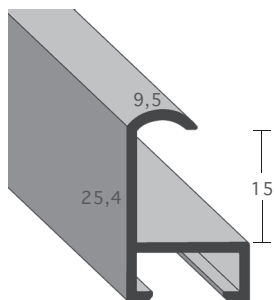

ARTIKELNUMMER	OMSCHRIJVING	CA. BREEDTE *MM
415 010 113	ECO zilver mat	9,5
415 010 123	Geborsteld zilver mat	9,5
415 010 493	Glanzend geborsteld zilver	9,5
415 011 123	Geborsteld champagne mat	9,5
415 011 493	Glanzend geborsteld champagne	9,5
415 012 123	Geborsteld goud mat	9,5
415 012 493	Glanzend geborsteld goud	9,5
415 013 113	ECO zwart mat	9,5
415 013 123	Geborsteld zwart mat	9,5
415 013 493	Glanzend geborsteld zwart	9,5
415 013 253	Zwart poedercoating	9,5
415 016 173	Geborsteld brons	9,5
415 017 253	Blauw poedercoating	9,5
415 022 253	Wit poedercoating RAL9016	9,5
415 023 253	Rood poedercoating	9,5
415 024 253	Geel poedercoating	9,5
415 025 253	Groen poedercoating	9,5
415 026 253	Grijs poedercoating	9,5
415 027 253	Glanzend wit RAL9003	9,5
415 018 363	Eiken fineer	9,5
415 019 363	Wenge fineer	9,5
415 020 363	Walnoot fineer	9,5
415 021 363	Mahonie fineer	9,5

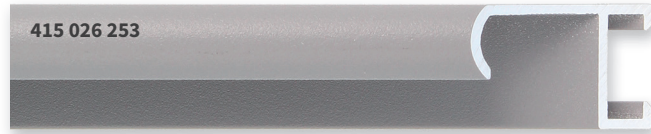
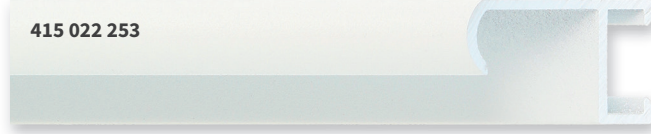
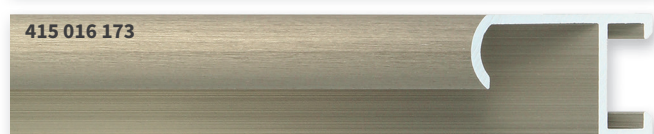
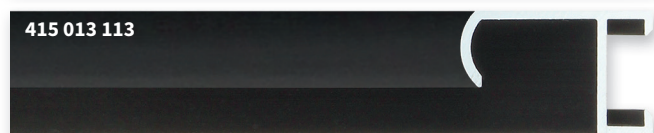

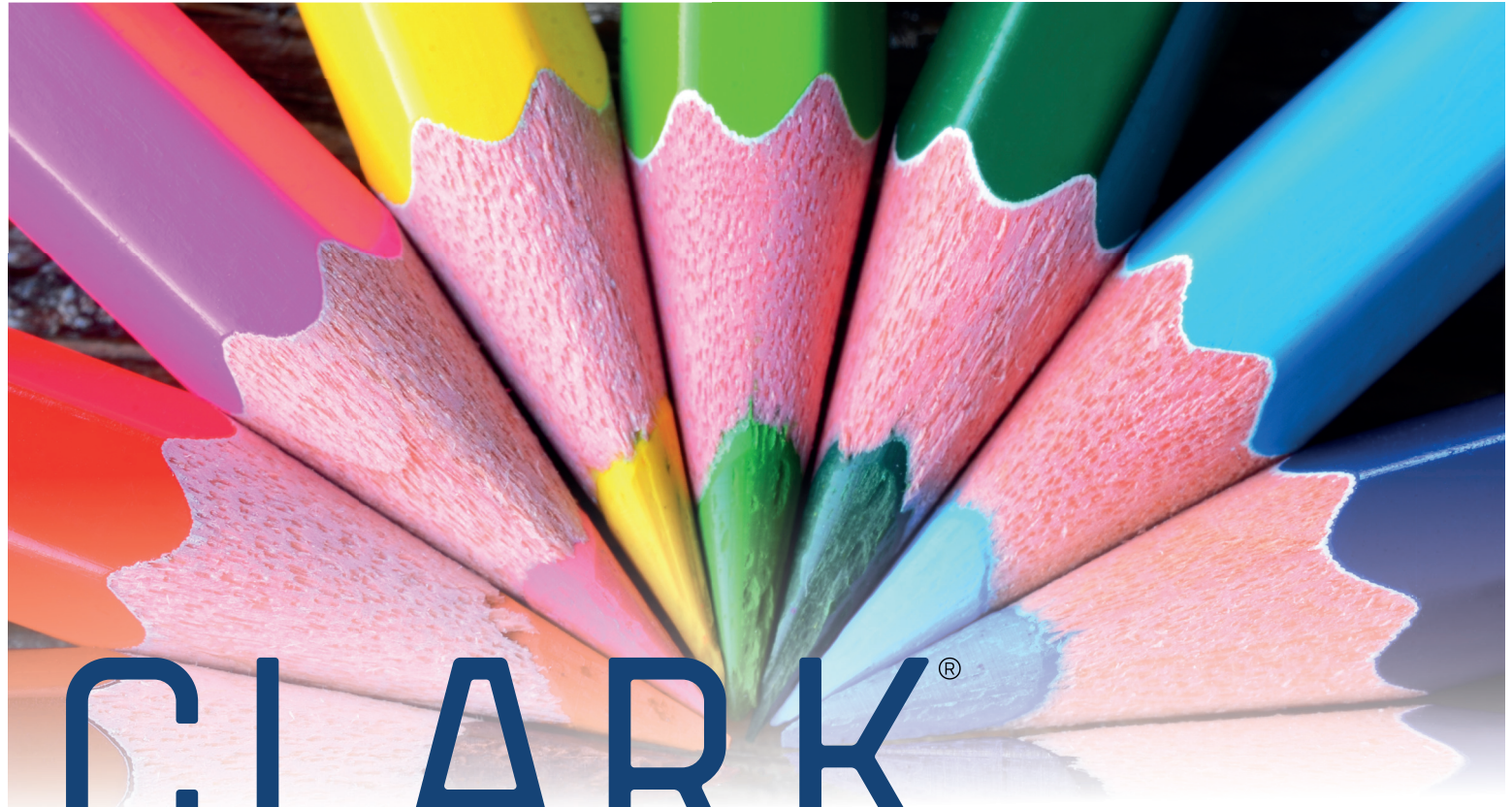

CLARK[®]

by Larson-Juhl



PROFIELSERIE 421-

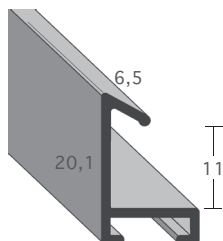

ARTIKELNUMMER	OMSCHRIJVING	CA. BREEDTE *MM
421 010 123	Geborsteld zilver mat	6,5
421 010 143	Kruisgeborsteld zilver	6,5
421 011 123	Geborsteld champagne mat	6,5
421 011 143	Kruisgeborsteld champagne	6,5
421 012 123	Geborsteld goud mat	6,5
421 012 143	Kruisgeborsteld goud	6,5
421 013 123	Geborsteld zwart mat	6,5
421 013 143	Kruisgeborsteld zwart	6,5



CLARK by Larson-Juhl Aluminium staaflijsten

PROFIELSERIE 422-

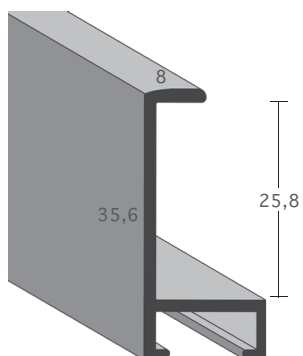

ARTIKELNUMMER	OMSCHRIJVING	CA. BREEDTE *MM
422 010 123	Geborsteld zilver mat	8
422 011 123	Geborsteld champagne mat	8
422 012 123	Geborsteld goud mat	8
422 013 123	Geborsteld zwart mat	8



PROFIELSERIE 427-

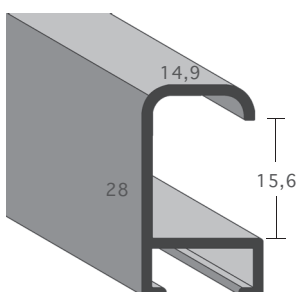

ARTIKELNUMMER	OMSCHRIJVING	CA. BREEDTE *MM
427 010 123	Geborsteld zilver mat	14,9
427 011 123	Geborsteld champagne mat	14,9
427 012 123	Geborsteld goud mat	14,9
427 013 123	Geborsteld zwart mat	14,9





CLARK[®]

by Larson-Juhl

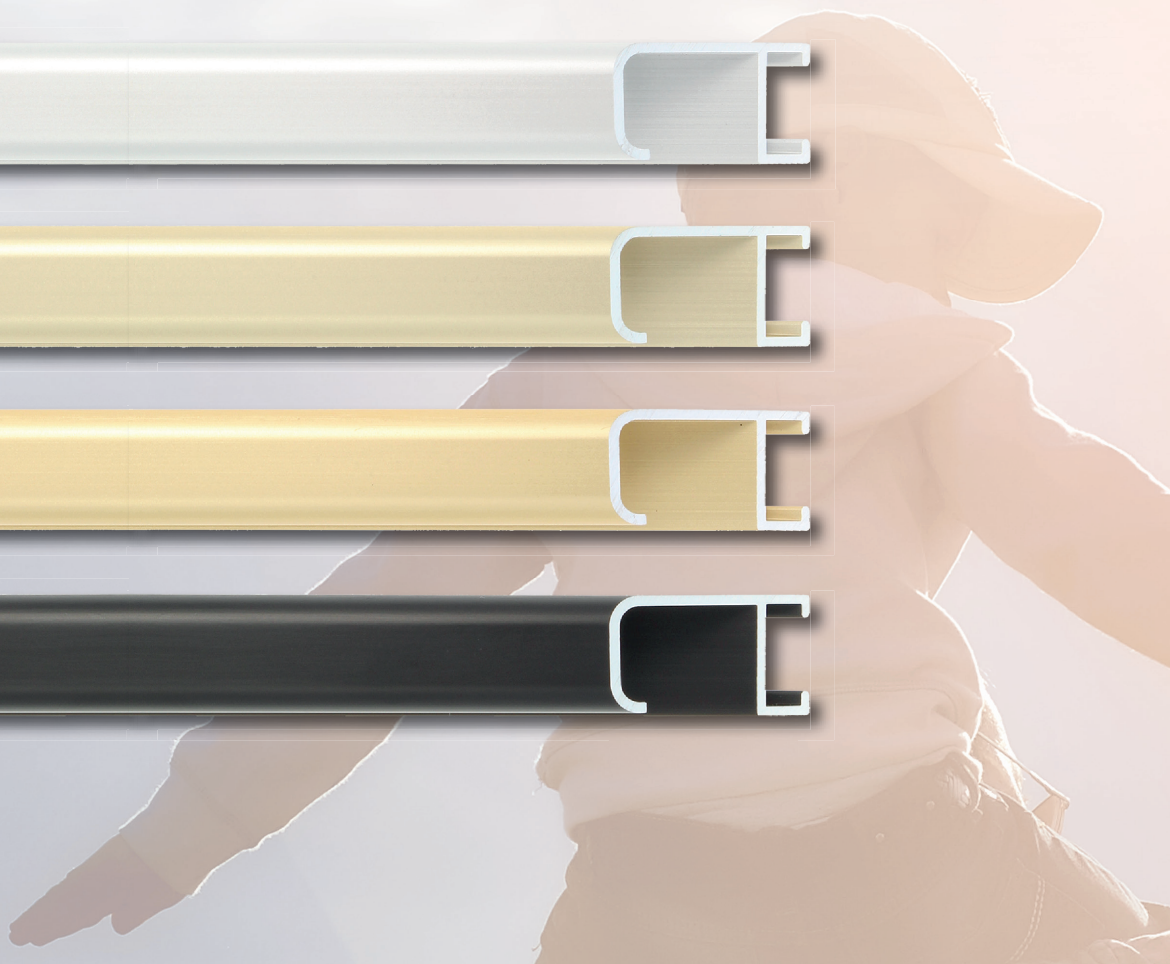

CLARK by Larson-Juhl Aluminium staaflijsten

PROFIELSERIE 428-

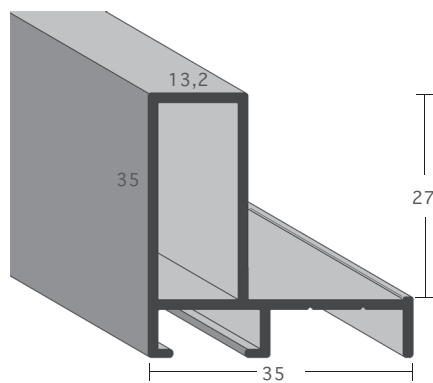

ARTIKELNUMMER	OMSCHRIJVING	CA. BREEDTE *MM
428 010 173	Geborsteld zilver baklijst	13,2
428 011 173	Geborsteld champagne baklijst	13,2
428 012 173	Geborsteld goud baklijst	13,2
428 013 173	Geborsteld zwart baklijst	13,2
428 018 363	Eiken fineer baklijst	13,2
428 019 363	Wenge fineer baklijst	13,2
428 020 363	Walnoot fineer baklijst	13,2
428 021 363	Mahonie fineer baklijst	13,2



PROFIELSERIE 450-

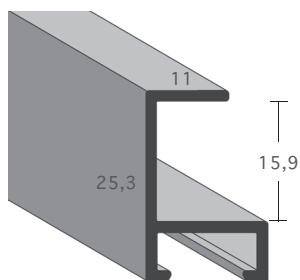

ARTIKELNUMMER	OMSCHRIJVING	CA. BREEDTE *MM
450 010 173	Geborsteld zilver mat	11
450 011 173	Geborsteld champagne mat	11
450 012 173	Geborsteld goud mat	11
450 013 173	Geborsteld zwart mat	11



CLARK by Larson-Juhl Aluminium staaflijsten

PROFIELSERIE 451-

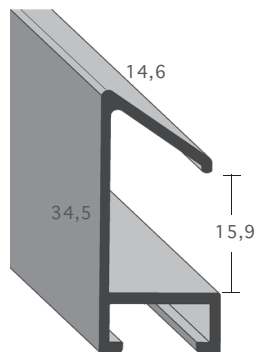

ARTIKELNUMMER	OMSCHRIJVING	CA. BREEDTE *MM
451 010 143	Kruisgeborsteld zilver	14,6
451 010 493	Glanzend geborsteld zilver	14,6
451 011 143	Kruisgeborsteld champagne	14,6
451 011 493	Glanzend geborsteld champagne	14,6
451 012 143	Kruisgeborsteld goud	14,6
451 012 493	Glanzend geborsteld goud	14,6
451 013 143	Kruisgeborsteld zwart	14,6
451 013 493	Glanzend geborsteld zwart	14,6

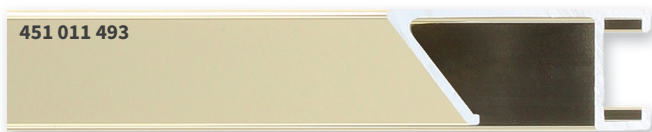
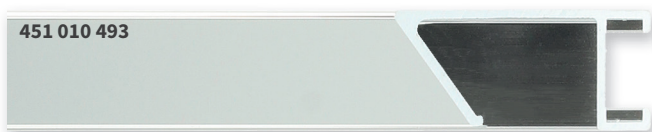



CLARK[®]

by Larson-Juhl

CLARK by Larson-Juhl Aluminium staaflijsten

PROFIELSERIE 462-

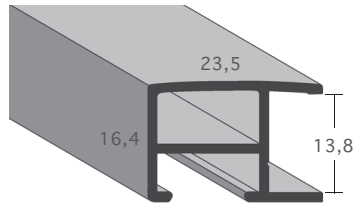

ARTIKELNUMMER	OMSCHRIJVING	CA. BREEDTE *MM
462 010 143	Kruisgeborsteld zilver	23,5
462 011 143	Kruisgeborsteld champagne	23,5
462 012 143	Kruisgeborsteld goud	23,5
462 013 143	Kruisgeborsteld zwart	23,5

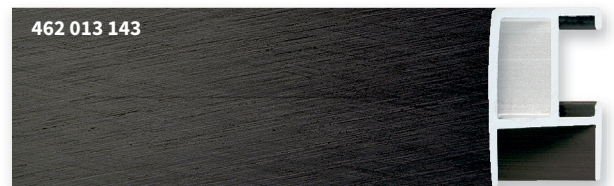



CLARK[®]

by Larson-Juhl

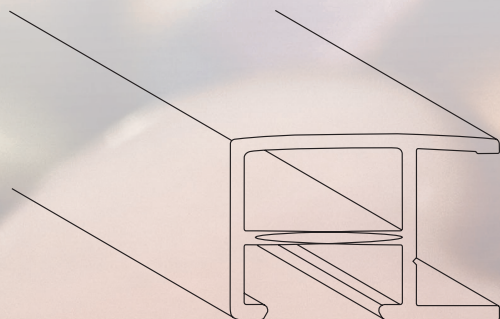

CLARK by Larson-Juhl Aluminium staaflijsten

PROFIELSERIE 469-

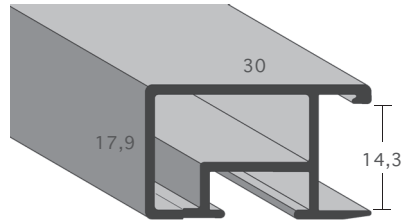

ARTIKELNUMMER	OMSCHRIJVING	CA. BREEDTE *MM
469 010 183	Geborsteld zilver mat	30
469 011 183	Geborsteld champagne mat	30
469 012 183	Geborsteld goud mat	30
469 013 183	Geborsteld zwart mat	30



CLARK by Larson-Juhl Aluminium staaflijsten

PROFIELSERIE 471-

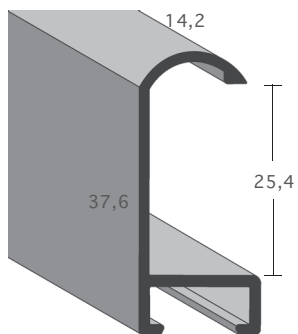

ARTIKELNUMMER	OMSCHRIJVING	CA. BREEDTE *MM
471 010 123	Geborsteld zilver mat	14,2
471 011 123	Geborsteld champagne mat	14,2
471 012 123	Geborsteld goud mat	14,2
471 013 123	Geborsteld zwart mat	14,2
471 018 363	Eiken fineer	14,2
471 019 363	Wenge fineer	14,2
471 020 363	Walnoot fineer	14,2
471 021 363	Mahonie fineer	14,2



CLARK by Larson-Juhl Aluminium staaflijsten

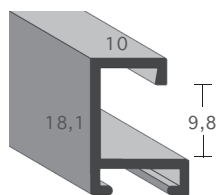

SERIE 403-

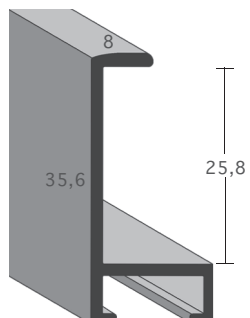

SERIE 422-

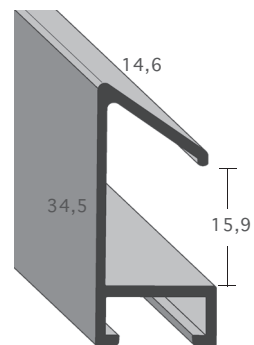

SERIE 451-

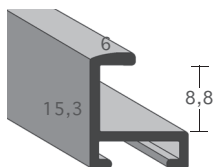

SERIE 404-

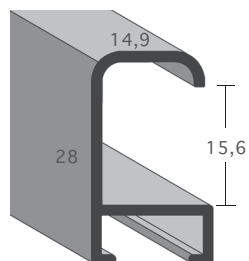

SERIE 427-

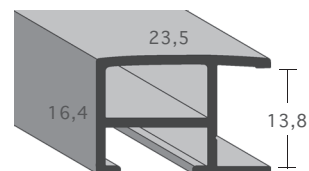

SERIE 462-

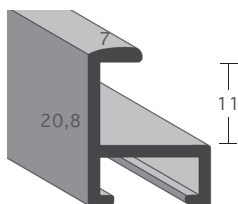

SERIE 411-

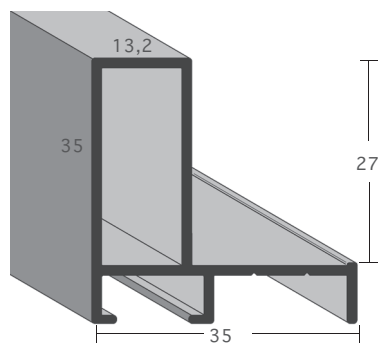

SERIE 428-

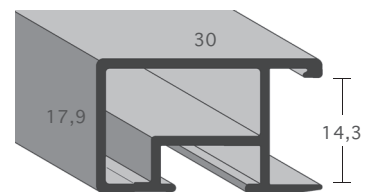

SERIE 469-

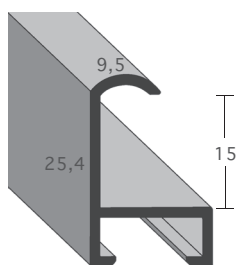

SERIE 415-

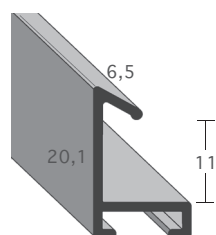

SERIE 421-

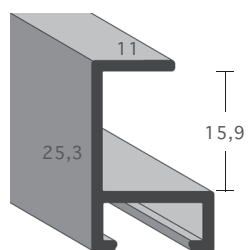

SERIE 450-

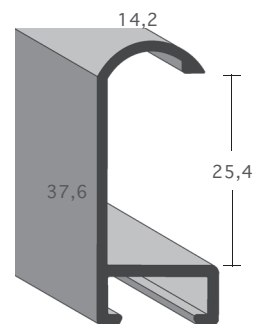

SERIE 471-

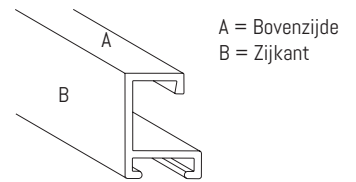

010 113

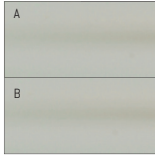

ECO zilver mat
BESCHIKBARE PROFIELEN:
411, 415

010 123

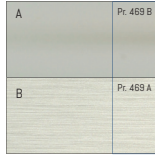

Geborsteld zilver mat
BESCHIKBARE PROFIELEN:
403, 404, 411 469
415, 421, 422
427, 471

010 183

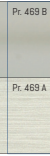

Pr. 469 B

Pr. 469 A

010 173

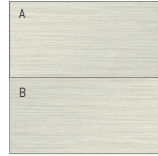

Geborsteld zilver
BESCHIKBARE PROFIELEN:
428, 450

010 493

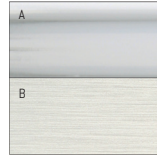

Geborsteld zilver glanzend
BESCHIKBARE PROFIELEN:
404, 411, 415, 451

010 143

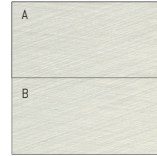

Kruisborsteld zilver
BESCHIKBARE PROFIELEN:
403, 404, 411
421, 451, 462

011 123

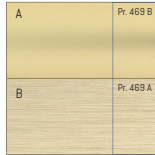

Geborsteld champagne mat
BESCHIKBARE PROFIELEN:
403, 404, 411 469
415, 421, 422
427, 471

010 183

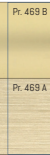

Pr. 469 B

Pr. 469 A

011 173

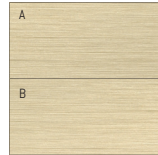

Geborsteld champagne
BESCHIKBARE PROFIELEN:
428, 450

011 493

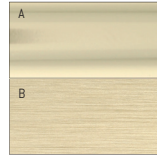

Geborsteld champ. glanzend
BESCHIKBARE PROFIELEN:
404, 411, 415, 451

011 143

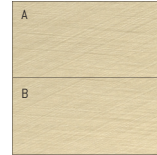

Kruisborsteld champagne
BESCHIKBARE PROFIELEN:
403, 404, 411
421, 451, 462

012 123

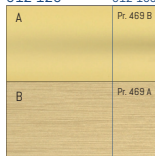

Geborsteld goud mat
BESCHIKBARE PROFIELEN:
403, 404, 411 469
415, 421, 422
427, 471

012 183

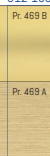

Pr. 469 B

Pr. 469 A

012 173



Geborsteld goud
BESCHIKBARE PROFIELEN:
428, 450

012 493



Geborsteld goud glanzend
BESCHIKBARE PROFIELEN:
404, 411, 415, 451

012 143

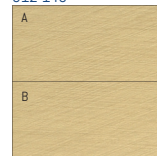

Kruisborsteld goud
BESCHIKBARE PROFIELEN:
403, 404, 411
421, 451, 462

013 113



ECO zwart mat
BESCHIKBARE PROFIELEN:
411, 415

013 123



Geborsteld zwart mat
BESCHIKBARE PROFIELEN:
403, 404, 411 469
415, 421, 422
427, 471

013 183



Pr. 469 B

Pr. 469 A

013 173



Geborsteld zwart
BESCHIKBARE PROFIELEN:
428, 450

013 493

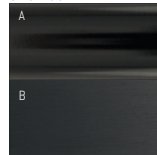

Geborsteld zwart glanzend
BESCHIKBARE PROFIELEN:
404, 411, 415, 451

013 143



Kruisborsteld zwart
BESCHIKBARE PROFIELEN:
403, 404, 411
421, 451, 462

016 173

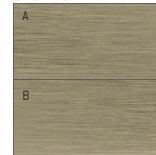

Geborsteld brons
BESCHIKBARE PROFIELEN:
411, 415

027 253

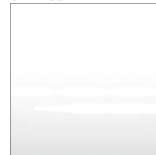

Wit gelakt RAL9003
BESCHIKBARE PROFIELEN:
415

013 253

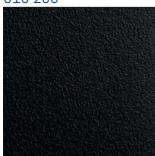

Zwart poedercoat RAL9005

BESCHIKBARE PROFIELEN:
404, 411, 415

017 253

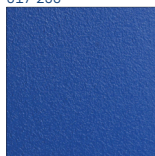

Blauw poedercoat RAL5002

BESCHIKBARE PROFIELEN:
404, 411, 415

022 253

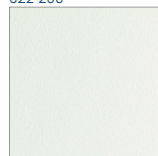

Wit poedercoat RAL9016

BESCHIKBARE PROFIELEN:
404, 411, 415

023 253

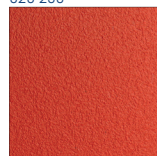

Rood poedercoat RAL3020

BESCHIKBARE PROFIELEN:
404, 411, 415

024 253

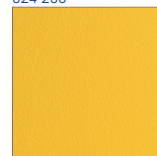

Geel poedercoat RAL1021

BESCHIKBARE PROFIELEN:
404, 411, 415

025 253



Groen poedercoat RAL6018

BESCHIKBARE PROFIELEN:
404, 411, 415

026 253

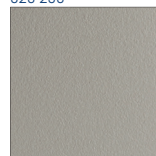

Grijs poedercoat RAL7036

BESCHIKBARE PROFIELEN:
404, 411, 415

018 363

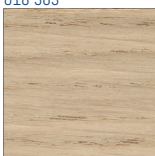

Eiken fineer
BESCHIKBARE PROFIELEN:
415, 428, 471

019 363

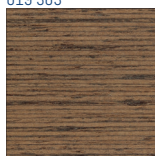

Wenge fineer
BESCHIKBARE PROFIELEN:
415, 428, 471

020 363

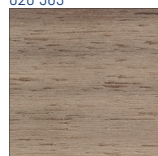

Walnoot fineer
BESCHIKBARE PROFIELEN:
415, 428, 471

021 363

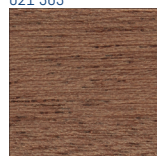

Mahonie fineer
BESCHIKBARE PROFIELEN:
415, 428, 471



BARTH[®]
LARSON · JUHL

Barth Larson-Juhl

Industrieweg 16, 5281 RW Boxtel (NL)
Postbus 83, 5280 AB Boxtel (NL)

Website: www.barthlarsonjuhl.nl